

Monkey Tail Operating Stay Bar

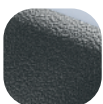

Features & Benefits

- Moveable 10" Monkey Tail operating stay bar
Add a classic finish to a heritage window
- Non-handed, suitable for both left and right handed windows
Reduced stock holding
- Manufactured from die-cast zinc
Harder wearing finish than traditional wrought ironmongery
- Peg plates to suit Residence 9 window system
Suitable for modern flush fitting PVC windows
- Matching Monkey Tail Handle also available
Create a perfectly matching heritage window
- Supplied with colour coordinated screws
Perfectly matching hardware, even down to the smallest detail



Antique
Black

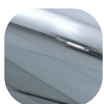

Hardex
Chrome

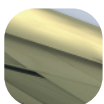

Hardex
Gold

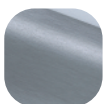

Hardex
Graphite

Monkey Tail Operating Stay Bar

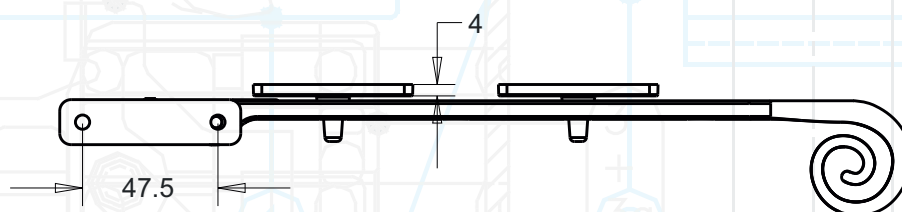
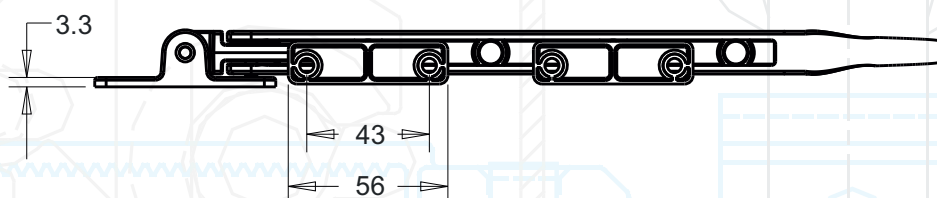
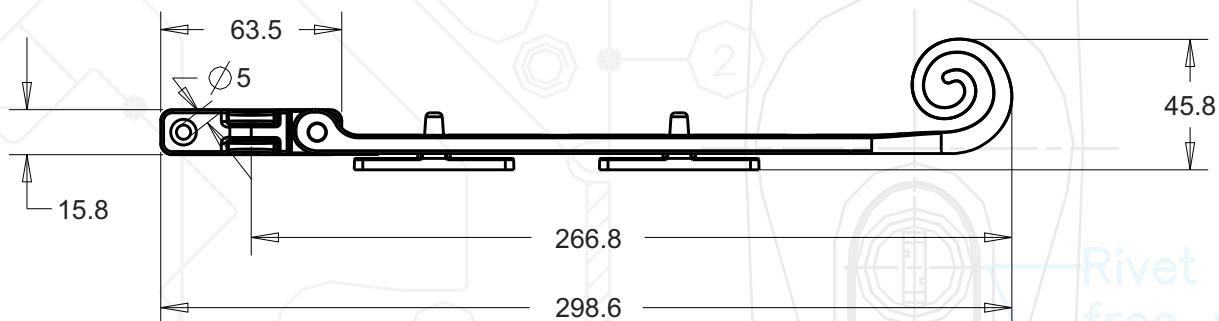

Rivet on item
free movement
numbers 2 a

Rivet on item 2 must allow
movement between item
numbers 2 and 1.

Technical Specification

All finishes salt spray tested to 480 hours
(BS EN 1670: Class 5)

Designed for PVC-U and Timber windows systems

Includes 6 x 4mm x 25mm colour coordinated screws

Product Codes

Monkey Tail Operating Stay Bar

Antique Black	Hardex Chrome	Hardex Gold	Hardex Graphite
8A089	8A091	8A092	8A090